



*More than 30 Years
Seit über 30 Jahren*

[audio physic]

No loss of fine detail

[CARDEAS 30]

Limited Jubilee Edition



Special features in comparison with CARDEAS plus+:

- Limited to 30 pairs, every Serial No. is embossed on the name plate
- Exclusively available in the Jubilee veneers Black Ebony High Gloss and Rosewood High Gloss
- Black High Gloss aluminum front plate
- Black High Gloss bottom plate
- Modified new HHCT III tweeter, easy recognizable on the aluminum-grey inner felt ring
- Exclusively modified VCT+ terminal
- Further optimized foot construction including VCF V Magnetic feet
- Exclusive Clarity Cap capacitors with copper foam technology

Besonderheiten im Vergleich zur CARDEAS plus+:

- Limitiert auf 30 Paare, jede Seriennummer ins Typenschild gelasert
- Exklusive Jubiläumsfurniere Black Ebony hochglanz und Rosewood hochglanz
- Aluminiumfrontplatte hochglanz schwarz
- Sockelplatte hochglanz schwarz
- Spezieller, neuer HHCT III Hochtöner, äußerlich an einem hellgrauen Filzring erkennbar
- Exklusiv modifiziertes VCT+ Terminal
- Weiter optimierte Fußkonstruktion – serienmäßig mit VCF V Magnetic-Füßen.
- Exklusive Clarity Cap Kondensatoren mit Kupferschaumtechnologie



VCF V Magnetic
inclusive / inklusive

CARDEAS 30
LIMITED JUBILEE EDITION
Rosewood high gloss
Rosenholz hochglanz



CARDEAS 30
LIMITED JUBILEE EDITION
Black Ebony high gloss
Ebenholz schwarz hochglanz

CARDEAS and CARDEAS plus® further available
CARDEAS und CARDEAS plus® weiterhin lieferbar

[AVANTI]



AVANTI
Glass White aluminium high gloss
Glas Weiß Alu hochglanz

Rebirth of a legend

Wiedergeburt einer Legende



AVANTI
Ebony
with optional bottom plate
Ebenholz
optional mit Sockelplatte



AVANTI
Walnut
with optional VCF II M8 Magnetic
Walnuss
optional mit VCF II M8 Magnetic



AVANTI
Rosewood high gloss
with optional VCF II M8 Magnetic
Rosenholz hochglanz
optional mit VCF II M8 Magnetic



AVANTI
Black Ebony high gloss
with optional bottom plate
Ebenholz schwarz hochglanz
optional mit Sockelplatte

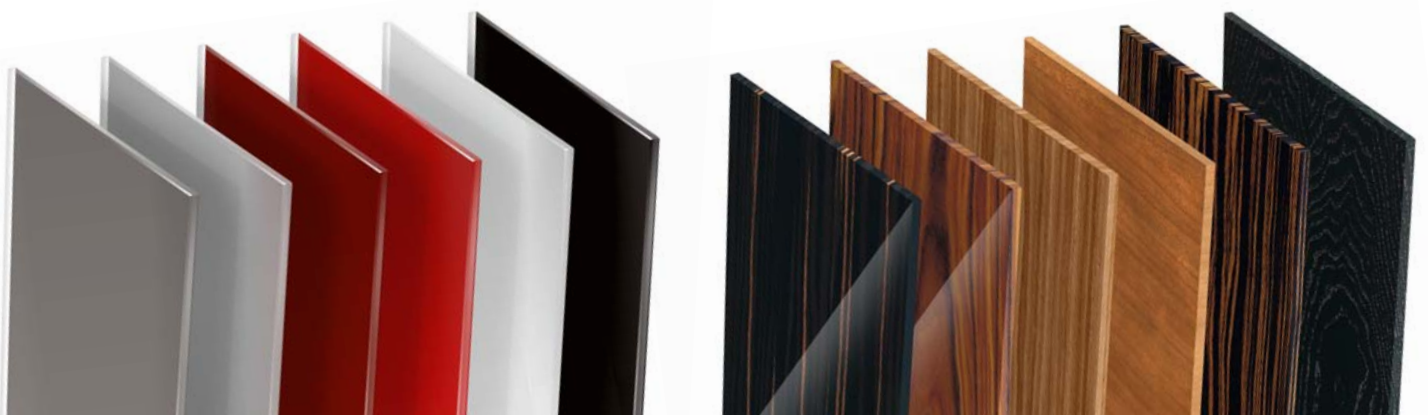



AVANTI
Glass Maranello red high gloss
with optional VCF II M8 Magnetic
Glas Maranello Rot hochglanz
optional mit VCF II M8 Magnetic



AVANTI
Glass white high gloss
Glas weiß hochglanz



AVANTI
Glass black high gloss / with optional bottom plate
Glas schwarz hochglanz / optional mit Sockelplatte

[AVANTI]

Rebirth of a legend

Wiedergeburt einer Legende

HHCT III Tweeter



HHCM III
Woofer/Midrange

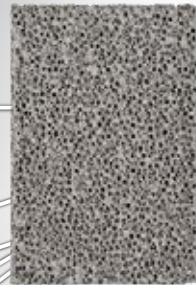

Ceramic foam
Keramikschaum



Vibration Control
Terminal II

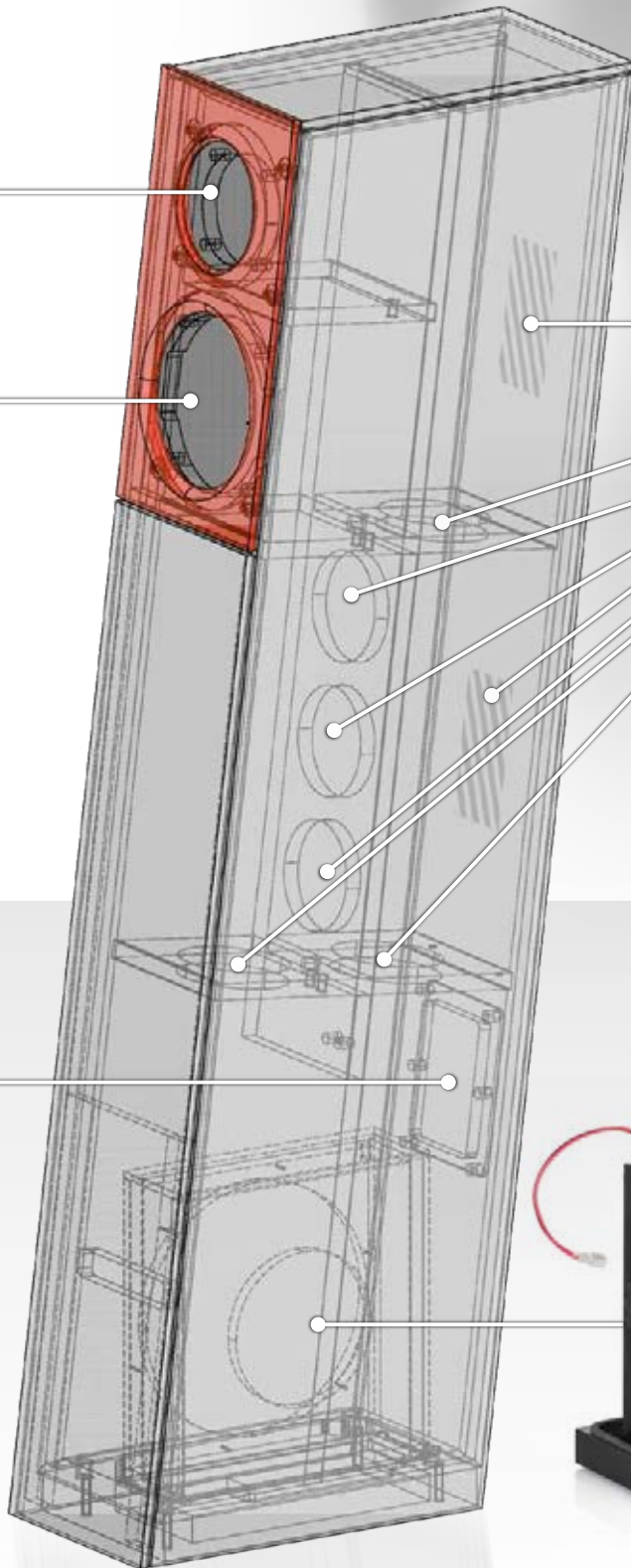

Subwoofer

[AVANTI]

The third generation / Die dritte Generation

Hyper-Holographic Cone Tweeter and Cone Midrange Driver



*HYPER-HOLOGRAPHIC
CONE MIDRANGE III*



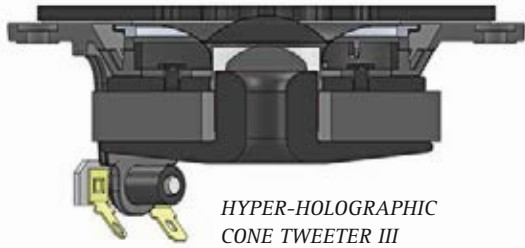

*HYPER-HOLOGRAPHIC
CONE TWEETER III*



*HYPER-HOLOGRAPHIC
CONE MIDRANGE III*



*HYPER-HOLOGRAPHIC
CONE TWEETER III*

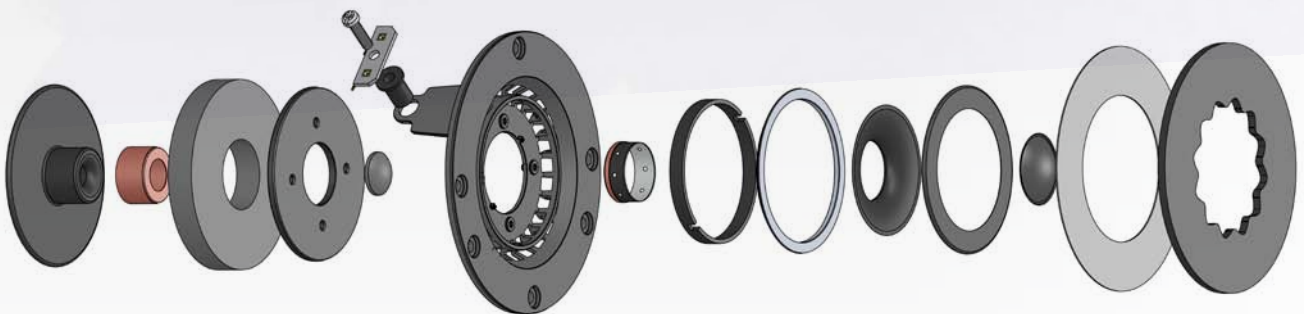

CLASSIC LINE
Glass black high gloss
Glas schwarz hochglanz



CLASSIC 30



CLASSIC 10



*CLASSIC
ON-WALL*



55" TV



CLASSIC CENTER



Glass finishes
Glasfarben

The innovative CLASSIC LINE



30



*LUNA Subwoofer**

CLASSIC COMPACT

CLASSIC 20

- Sandwich cabinet construction
- Innovative surfaces: Glass high gloss
- New bass reflex construction integrated into the sandwich construction (CLASSIC 10, Center and Compact)
- Specially developed loudspeaker systems
- Connection terminal with WBT nextgen™ binding posts
- Interchangeable front panels (open or covered in fabric)

* Without WBT nextgen™ terminals

- Sandwich-Gehäuse-Konstruktion
- Innovative Oberflächen: Glas Hochglanz
- In die Sandwichkonstruktion integrierte, neuartige Bassreflexkonstruktion (CLASSIC 10, Center, Compact)
- Eigens entwickelte Lautsprechersysteme.
- Anschlussterminal mit WBT nextgen™ Klemmen.
- Austauschbare Frontblenden (offen oder mit Stoff bespannt).

* Ohne WBT nextgen™ Klemmen

[AVANTERA plus®]

[TEMPO 25 plus®]



AVANTERA plus®
Oak / Eiche



TEMPO 25 plus®
Walnut / Walnuss

30

[STEP 25^{plus}®]

[VIRGO 25^{plus}®]

[CELSIUS CENTER 25^{plus}®]



*STEP 25^{plus}®
Black high gloss
Schwarz hochglanz*



*CELSIUS CENTER 25^{plus}®
White high gloss
Weiß hochglanz*



*VIRGO 25^{plus}®
White high gloss
with optional VCF III Double M8
Weiß hochglanz
optional mit VCF III Double M8*



VCF V Magnetic Vibration Control Feet



Adapter 24 mm

Adapter 34 mm

Component adapter



VCF V Magnetic M8:
With adapter mounted 24 mm
Mit 24 mm Adapter



VCF V Magnetic M8:
With adapter mounted 34 mm
Mit 34 mm Adapter



VCF V Magnetic M8:
Component adapter
Adapter für Komponenten

VCF II Magnetic Vibration Control Feet



*VCF II Magnetic M8:
optimal performance up to 10 kg pp,
limited at max 15 kg pp
optimal bis 10 kg pro Einzelfuß,
maximal bis 15 kg pro Einzelfuß*



*VCF II Magnetic M8, white:
optimal performance up to 10 kg pp,
limited at max 15 kg pp
optimal bis 10 kg pro Einzelfuß,
maximal bis 15 kg pro Einzelfuß*



*VCF II Magnetic Component:
optimal performance up to 10 kg pp,
limited at max 15 kg pp (without felt pad)
optimal bis 10 kg pro Einzelfuß,
maximal bis 15 kg pro Einzelfuß (ohne Filzplättchen)*



*VCF II Magnetic Component, felt pad mounted:
optimal performance up to 10 kg pp,
limited at max 15 kg pp (with felt pad)
optimal bis 10 kg pro Einzelfuß,
maximal bis 15 kg pro Einzelfuß (mit Filzplättchen)*

Sherpa loudspeaker stand

Dimensions / Abmessungen (mm):

Height without spikes /

Höhe ohne Spikes: 665

Top plate / Topplatte: 200 x 150

Base plate / Basisplatte: 365 x 260

Accessories / Zubehör: M8 Spikes



*SHERPA black
SHERPA schwarz*



*SHERPA silver
SHERPA silber*



*SHERPA white with
CLASSIC Compact (not included)
SHERPA weiß mit CLASSIC
Compact (nicht im Lieferumfang)*

[Technische Daten]

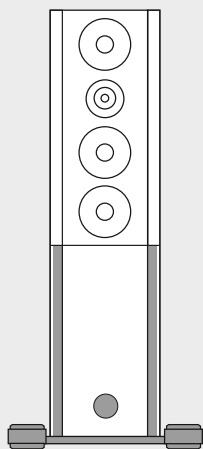

CARDEAS 30
LIMITED JUBILEE EDITION

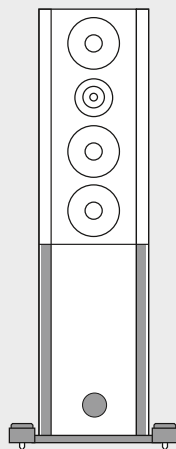

CARDEAS plus®

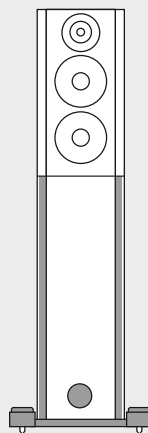

AVANTERA plus®

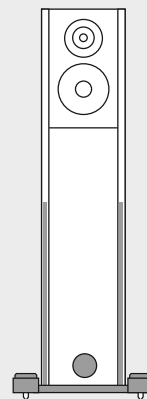

VIRGO 25 plus®

Height / Höhe:	1190 mm / 46.9"	1190 mm / 46.9"	1150 mm / 45.3"	1055 mm / 41.5"
Width / Breite:	305 mm / 12"	305 mm / 12"	240 mm / 9.4"	230 mm / 9.1"
Depth / Tiefe:	595 mm / 23.4"	595 mm / 23.4"	420 mm / 16.5"	400 mm / 15.7"
Required space (WxD) Grundfläche (BxT):	410 mm x 595 mm 16.1" x 23.4"	410 mm x 595 mm 16.1" x 23.4"	370 mm x 500 mm 14.6" x 19.7"	370 mm x 470 mm 14.7" x 18.5"
Weight / Gewicht:	~ 74 kg	~ 74 kg	~ 46.5 kg	~ 35 kg
Recommended amplifier power/ Empfohlene Verstärkerleistung:	40 – 350 W	40 – 350 W	40 – 250 W	30 – 180 W
Impedance / Impedanz:	4 Ω	4 Ω	4 Ω	4 Ω
Frequency range / Frequenzgang:	25 Hz – 40 kHz	25 Hz – 40 kHz	28 Hz – 40 kHz	30 Hz – 40 kHz
Sensitivity / Wirkungsgrad:	89 dB	89 dB	89 dB	89 dB

Finishes



* on request / auf Anfrage

*It is the fine real wood veneer finish that makes a loudspeaker unique. Texture and wood grain gives each one its own unique look.
Ein erstklassiges Echtholz-Furnier macht jeden Lautsprecher zum Einzelstück. Keine Struktur, keine Maserung gleicht der anderen.*

30

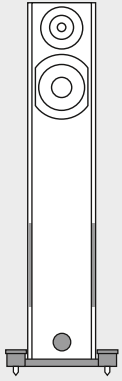

TEMPO 25^{plus}®



STEP 25^{plus}®



CELSIUS CENTER 25^{plus}®

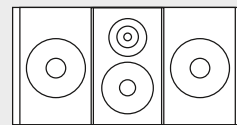

OREA CENTER^{plus}®

1000 mm / 39.4"	320 mm / 12.6"	145 mm / 5.7"	330 mm / 13"
187 mm / 7.4"	175 mm / 6.9"	487 mm / 19.2"	634 mm / 24.9"
320 mm / 12.6"	250 mm / 9.8"	300 mm / 11.8"	340 mm / 13.3"
290 mm x 430 mm 11.4" x 16.9"	175 mm x 300 mm 6.9" x 11.8"	490 mm x 330 mm 19.3" x 13.0"	-
~ 20 kg	~ 5.5 kg	~ 10 kg	~ 23 kg
20 - 150 W	10 - 120 W	20 - 140 W	25 - 180 W
4 Ω	8 Ω	4 Ω	4 Ω
32 Hz - 40 kHz	50 Hz - 40 kHz	44 Hz - 40 kHz	40 Hz - 40 kHz
89 dB	87 dB	89 dB	90 dB

Special Finishes

Walnut
Walnuss

White high gloss
Weiß hochglanz

Black high gloss
Schwarz hochglanz

[Technische Daten]

[CLASSIC LINE]

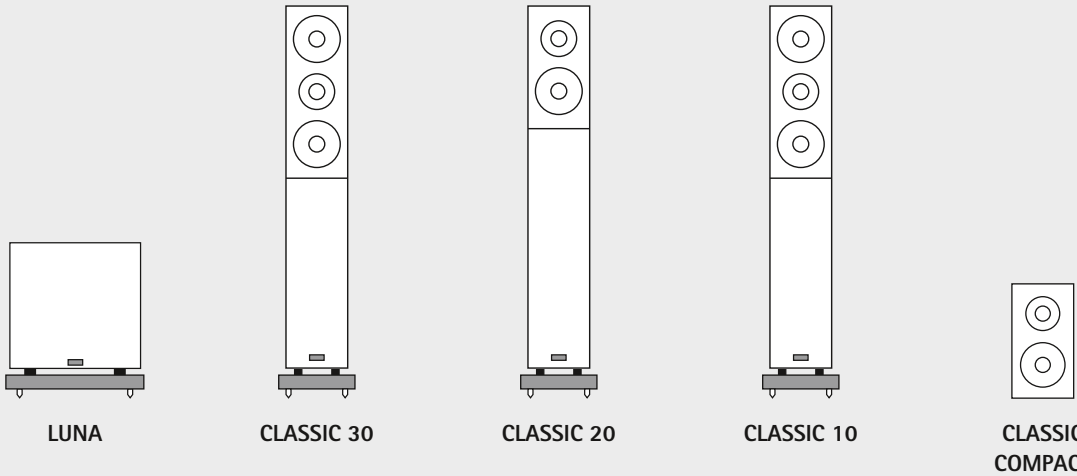

	LUNA	CLASSIC 30	CLASSIC 20	CLASSIC 10	CLASSIC COMPACT
Height / Höhe:	400 mm / 15.8"	1055 mm / 41.5"	1055 mm / 41.5"	1055 mm / 41.5"	315 mm / 12.4"
Width / Breite:	360 mm / 14.2"	170 mm / 6.7"	170 mm / 6.7"	170 mm / 6.7"	170 mm / 6.7"
Depth / Tiefe:	360 mm / 14.2"	410 mm / 16.1"	290 mm / 11.4"	240 mm / 9.5"	240 mm / 9.5"
Grundfläche (BxT)	380 x 380 mm	210 x 470 mm	210 x 350 mm	210 x 300 mm	170 x 240 mm
Required space (WxD):	15" x 15"	8.3" x 18.5"	8.3" x 13.8"	8.3" x 11.8"	6.7" x 9.5"
Weight glass / Gewicht Glas:	~ 21 kg	~ 33 kg	~ 23 kg	~ 21.5 kg	~ 9 kg
Weight veneer / Gewicht Furnier:	~ 19 kg	~ 26 kg	~ 18 kg	~ 16.5 kg	~ 7 kg
Recommended amplifier power / Empfohlene Verstärkerleistung:	-	25 – 180 W	25 – 150 W	20 – 120 W	20 – 100 W
Impedance / Impedanz:	600/30.000 Ω	4 Ω	4 Ω	4 Ω	8 Ω
Frequency range / Frequenzgang:	30 Hz - 150 kHz	31 Hz - 30 kHz	34 Hz - 30 kHz	38 Hz - 30 kHz	50 Hz - 30 kHz
Sensitivity / Wirkungsgrad:	-	89 dB	89 dB	89 dB	86 dB

[CLASSIC LINE] + [AVANTI]

Special High Gloss Glass Finishes

Exclusively for CLASSIC LINE and AVANTI / Ausschließlich für die CLASSIC LINE und AVANTI



30



**CLASSIC
CENTER**

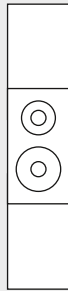

**CLASSIC
ON-WALL***

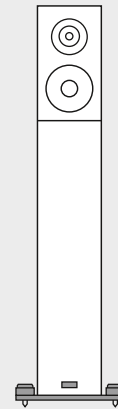

AVANTI

170 mm / 6.7"	785 mm / 30.7"
455 mm / 17.9"	170 mm / 6.7"
240 mm / 9.5"	90 mm / 3.5"
455 x 240 mm	-
17.9" x 9.5"	
~ 10.5 kg	~ 8.5 kg
~ 9.5 kg	~ 8.5 kg
20 - 100 W	20 - 100 W
4 Ω	8 Ω
44 Hz - 30 kHz	50 Hz - 30 kHz
89 dB	86 dB

Height / Höhe:	1087 mm / 42.8"
Width / Breite:	170 mm / 6.7"
Depth / Tiefe:	390 mm / 15.4"
Grundfläche (BxT)	300 x 400 mm
Required space (WxD):	11.8" x 15.7"
Weight glass / Gewicht Glas:	~ 29 kg
Weight veneer / Gewicht Furnier:	~ 24 kg
Recommended amplifier power/ Empfohlene Verstärkerleistung:	30 - 180 W
Impedance / Impedanz:	4 Ω
Frequency range / Frequenzgang:	31 Hz - 40 kHz
Sensitivity / Wirkungsgrad:	88 dB

* Exclusively in glass black or white high gloss
Ausschließlich in Glas Schwarz oder Weiß hochglanz

[CLASSIC LINE] + [AVANTI]

Finishes

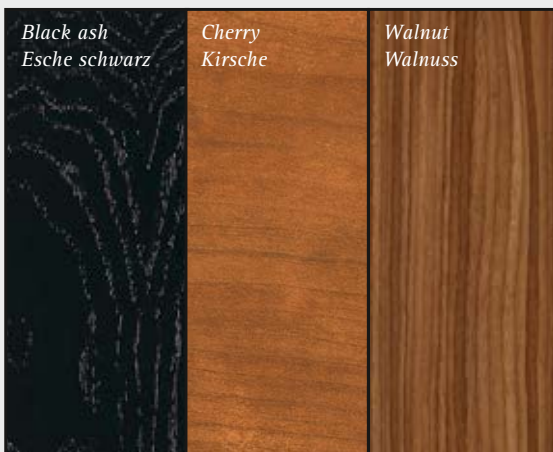

[AVANTI]

Additional finishes / Zusätzliche Furniere



*It is the fine real wood veneer finish that makes a loudspeaker unique. Texture and wood grain gives each one its own unique look.
Ein erstklassiges Echtholz-Furnier macht jeden Lautsprecher zum Einzelstück. Keine Struktur, keine Maserung gleicht der anderen.*

[audio physic]

No loss of fine detail

*Audio Physic GmbH
Almerfeldweg 38
59929 Brilon - Germany
Tel. +49 (0)2961-96170
Fax +49 (0)2961-51640
info@audiophysic.de
www.audiophysic.de*