

For more details visit www.atacama-audio.co.uk

PRODUCT RANGE

Atacama

Multi-Media Furniture Specialist

Evoque Eco 60-40 SE Evoque Eco 60-40



**WHAT HI-FI?
AWARDS 2015**

Accessories
Best equipment rack
Atacama Evoque Eco 60-40
Special Edition

**WHAT HI-FI?
AWARDS 2014**

Accessories
Best equipment support
Atacama Evoque Eco 60-40

**WHAT HI-FI?
SOUND AND VISION**

★★★★★
October 2014



Eris Eco 5.0

**WHAT HI-FI?
SOUND AND VISION
WHATHIFI.COM
AWARDS 2013**

ACCESSORIES
BEST EQUIPMENT SUPPORT
ATACAMA ERIS ECO 5.0

**WHAT HI-FI?
SOUND AND VISION
WHATHIFI.COM
AWARDS 2012**

ACCESSORIES
BEST EQUIPMENT SUPPORT
ATACAMA ERIS ECO 5.0



March 2013
Elite Eco 12.0

**WHAT HI-FI?
SOUND AND VISION**
★★★★★



UK Made



UK Made

**WHAT HI-FI?
AWARDS 2015**

Accessories
Best speaker stand
Atacama Moseco 6

**WHAT HI-FI?
AWARDS 2014**

Accessories
Best speaker stand
Atacama Moseco 6

**WHAT HI-FI?
SOUND AND VISION**

★★★★★
October 2014

Moseco 6 Speaker Stands



UK Made
Issue 1
2016



Nexus 6i
September 2003

**WHAT HI-FI?
SOUND AND VISION**

★★★★★

Atacama

TECHNICAL SPECIFICATIONS

ERIS ECO 5.0 HiFi SUPPORT
COLOUR OPTIONS

**BAMBOO
COLOUR
SWATCH**

**ELARA 3-600 HiFi & CM
(CABLE MANAGEMENT)**

**ERIS ECO 5.0
& SPECIAL EDITION**

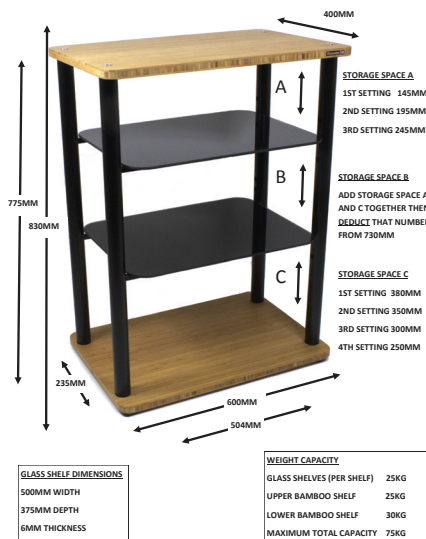

Weight capacity 20kg per level dependent on overall storage requirement.
Maximum number of modules = Base + 3 Shelves



Please note—Bamboo is a natural material so colour, texture, grain and age may give a variable appearance to each module.

**ATACAMA EVOQUE ECO 60-40
SPECIAL EDITION**

**ATACAMA EVOQUE ECO 60-40 & ECO 110-40
ATACAMA EVOQUE ECO 24-16 & 44-16**

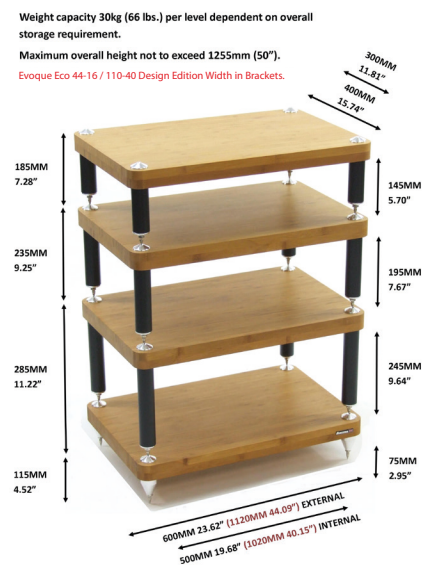

Weight capacity 30kg (66 lbs.) per level dependent on overall storage requirement.
Maximum overall height not to exceed 1255mm (50").
Evoque Eco 44-16 / 110-40 Design Edition Width in Brackets.

EQUINOX COLOUR SWATCHES

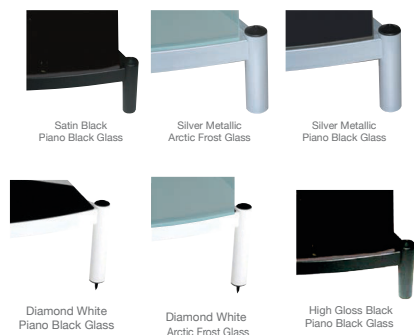

**EQUINOX HiFi RS
+ RS CELEBRATION**

EQUINOX AV & AV ECO

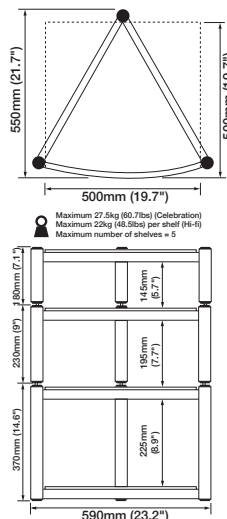

- Total shared load capacity 100kgs
- Maximum load capacity per shelf 75kgs
- Total shared load capacity with optional shelf 125kgs

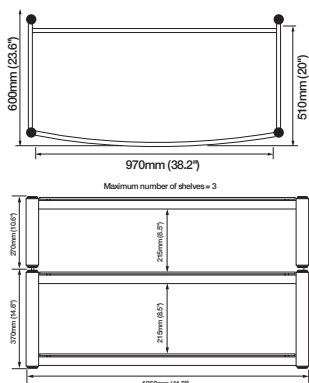

ELITE ECO 12.0



We operate a policy of continuous improvement and reserve the right to amend designs and specifications without prior notice.
All dimensions shown in this brochure are approximate only.

Atacama

TECHNICAL SPECIFICATIONS

NEXUS SERIES

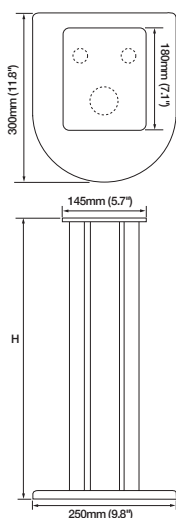

Model	Height 'H'
Nexus 5	500mm (19.7")
Nexus 6	600mm (23.6")
Nexus 7	700mm (27.6")
Nexus 10	1000mm (39.4")

The height of each model excluding spikes.

MOSECO SERIES

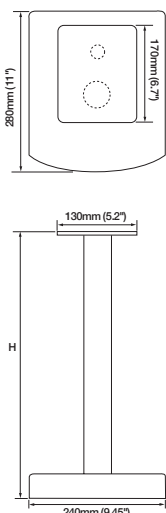

Model	Height 'H'
Moseco 5	515mm (20.3")
Moseco 6	615mm (24.2")
Moseco 7	715mm (28.1")
Moseco 10	1015mm (40.0")

The height of each model excluding spikes.

HMS 1.1 SERIES

3 height options of 500mm, 600mm and 700mm.

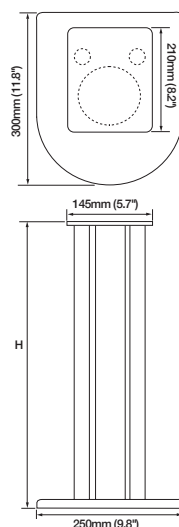

HMS 2.1

1 height option of 600mm

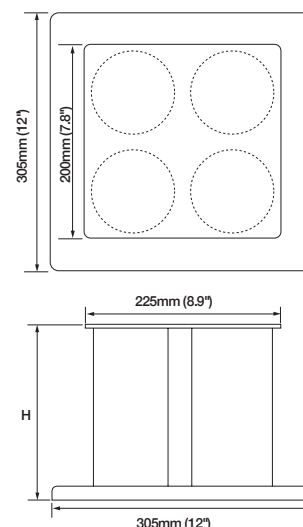

CC SERIES

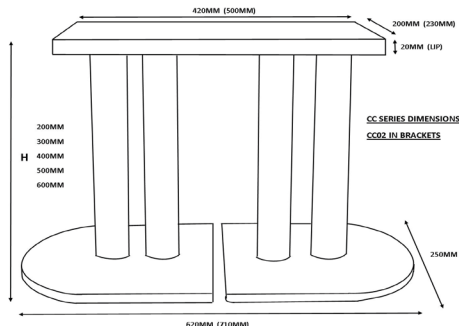

CC SERIES DIMENSIONS
CC02 IN BRACKETS

MOSECO CC SERIES

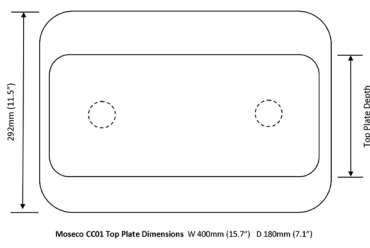

Moseco CC01 Top Plate Dimensions W 400mm (15.7") D 180mm (7.1")
Moseco CC02 Top Plate Dimensions W 475mm (18.7") D 210mm (8.3")
Moseco CC03 Top Plate Dimensions W 550mm (21.65") D 250mm (9.8")

WSS SPEAKER STAND

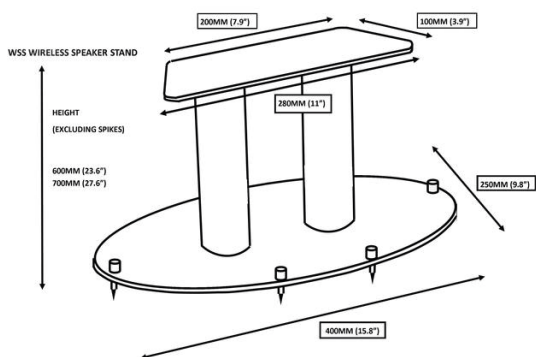

SL SERIES

Model	Height 'H'
SL200	200mm (7.9")
SL300	300mm (11.8")
SL400	400mm (15.8")
SL500	500mm (19.7")
SL600	600mm (23.6")
SL700	700mm (27.6")
SL1000	1000mm (39.4")

The height of each model excluding spikes.

Custom sized top plates are available upon request.

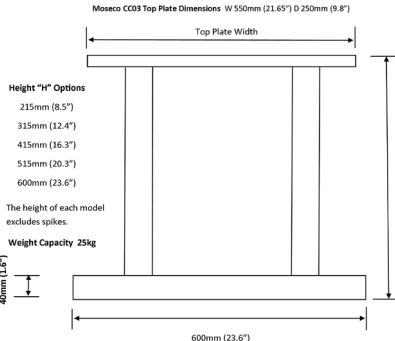

Height "H" Options
215mm (8.5")
315mm (12.4")
415mm (16.3")
515mm (20.3")
600mm (23.6")

The height of each model excludes spikes.

Weight Capacity 25kg

40mm (1.6")

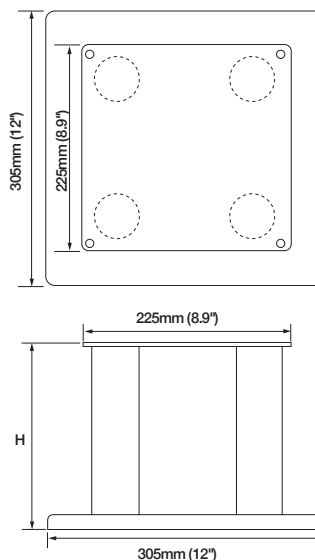

ATACAMA HD-S & HD-L Floor Spike Shoes

Atacama High Density spike shoes are made of a copper /zinc alloy construction and features an indentation on the upper surface to locate the spike and on its lower surface, a non slip E.P.D.M. elastomer membrane designed to protect delicate floor coverings and aid sound dampening. Each spike shoe has a diameter of 20mm (HD-S) and 25mm (HD-L), making the HD-S best suited to small and medium sized speaker stands, HD-L suitable for most large speaker stands and HiFi rack applications with an overall maximum weight spread over all four shoes of 70kg (HD-S), 125kg (HD-L). They are available in a choice of two colours, Satin Black or Nickel Silver.



ATABITES SMD-Z 7.5HD

PLEASE NOTE- Atabites are supplied by weight, not volume. (7.5 kg tubs). Some settling of contents may occur in transit. Here is the maximum approximate weight of Atabites that can be used in each pair of speaker stands:-

Moseco 5=7kg Moseco 6=10.4kg Moseco 7=12.2kg Moseco 10=15kg

Nexus 6i=8.2kg Nexus 7i=12.2kg Nexus10i=21kg SL200=7.2kg SL300=15.2kg SL400=24kg SL500=32.8kg

SL600=41.6kg SL700=48.8kg SL1000=68kg

HMS1.1 & Moseco XL 500mm=34kg

HMS1.1 & Moseco XL 600mm=41.8kg

HMS1.1 700mm=55.4kg HMS2.1=84kg.

Sonic results will depend on speaker stand positioning, type of speaker, room size, type of electronics and cabling, listening position and personal taste. However, as a guide, filling the stands approximately two thirds full generally gives the best results.

Atacama

ATACAMA EVOQUE ECO 60-40 SPECIAL EDITION

Natural Bamboo Finish

Atacama Evoque Eco 60-40 Special Edition

The Modular Evoque Eco Special Edition features ASIST Dampening Gaskets, Mechanical Grounding and top of the line modular Isolation Components that are fitted as standard to all Evoque's, along with the latest Hifi support innovations pioneered by Atacama such as Vectored Resonance Deflection Channels, Leg Tuning Counterweights, Mechanically Tuned Leg Lengths and Bronze Isolation Coned Spikes, all designed to give the best possible acoustic performance possible.

WHAT HI-FI?
SOUND AND VISION



October 2015

WHAT HI-FI?
AWARDS 2015

Accessories

Best equipment rack
Atacama Evoque Eco 60-40
Special Edition

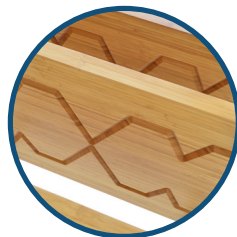

VRDC Grooves



Counterweighted
leg isolation
(picture in cut out)



Bronze Isolation Cones

Moseco XL series

Introducing the flagship of the Moseco range, the Moseco XL speaker stands are supplied as matched pairs and feature a substantial 5mm thick, 200mm wide by 275mm deep carbon steel top plate specifically designed to support large bookshelf style speakers. Four domed isolation gel pads are also included with each top plate to protect and dampen the cabinet of the supported speaker.

MOSECO XL SERIES

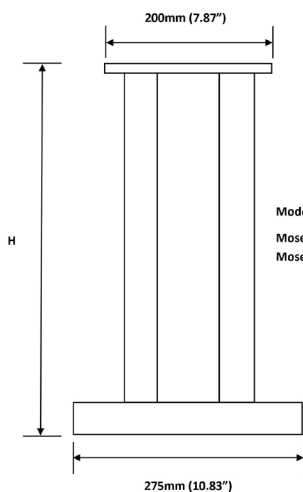
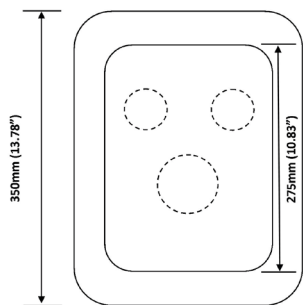

Model	Height "H"
Moseco XL500	520mm (20.47")
Moseco XL600	620mm (24.4")



UK Made



Atacama

EQUIPMENT SUPPORTS

Elara 3-600 CM

Satin black / Medium Finish Bamboo



Evoque Eco Custom

Satin black / Natural Finish Bamboo



EVOQUE ECO CUSTOM

BASED AROUND THE AWARD WINNING EVOQUE ECO 60-40, THE EVOQUE ECO CUSTOM ALLOWS YOU TO SELECT THE WIDTH, DEPTH, SHELF COLOUR FINISH, LEG HEIGHT AND NUMBER OF SHELVES REQUIRED TO MAKE AN EVOQUE THAT FITS AROUND YOUR SPECIFIC AV EQUIPMENT STORAGE REQUIREMENT.

UK ONLY, SPEAK TO YOUR LOCAL ATACAMA DEALER OR REFER TO THE ATACAMA WEBSITE FOR MORE DETAILS.

EQUINOX HIFI CELEBRATION

SATIN BLACK / PIANO BLACK GLASS



Corner shelf detail.

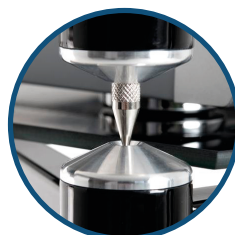

Spike / cone interface.



Spike shoe option.
(Gloss Black Frame Option)

GLOSS BLACK / PIANO BLACK GLASS



Equinox Range



A.R.C. Glass

"A worthy upgrade... adding verve and insight"
What HiFi? Sound & Vision Magazine

May 2011



EQUINOX AV BASE MODULE WITH AV SHELF MODULE



SILVER METALLIC / ARCTIC FROST GLASS.



SATIN BLACK / PIANO BLACK GLASS.



DIAMOND WHITE / PIANO BLACK GLASS.



Evoque Eco 44-16

Design Edition

SPEAKER STANDS



SATIN BLACK - NEXUS 6i



September 2003



WHAT HI-FI?
AWARDS 2015

Accessories
Best speaker stand
Atacama Moseco 6

WHAT HI-FI?
AWARDS 2014

Accessories
Best speaker stand
Atacama Moseco 6

WHAT HI-FI?
SOUND AND VISION



October 2014



WSS SPEAKER STAND
1000MM



SATIN BLACK - HMS 2.1 600



CC01-300
CENTRE CHANNEL STAND

MOSECO 6
GLOSS BLACK / NATURAL FINISH BAMBOO



DIAMOND WHITE - SL400i



SATIN BLACK - HMS 1.1 700



UK Made



**A BRITISH
MANUFACTURING
COMPANY**

Atacama offer a full 2 years guarantee on all Atacama products, giving you peace of mind and assurance of quality.

Sambell Engineering Ltd

Winston Avenue

Croft, Leicester LE9 3GQ

Tel: 01455 283251

Fax: 01455 283908

Email: post@atacama-audio.co.uk

Web: www.atacama-audio.co.uk

Atacama

Multi-Media Furniture Specialist